

# 4/2 and 4/3 proportional directional valves, direct operated, without electrical position feedback

**RE 29055-XE-B2/09.13**  
Replaces: 07.04

**Type 4WRA 6 ../..XE...**

Size 6  
Component series 2X  
Maximum operating pressure 315 bar  
Maximum flow 22 l/min

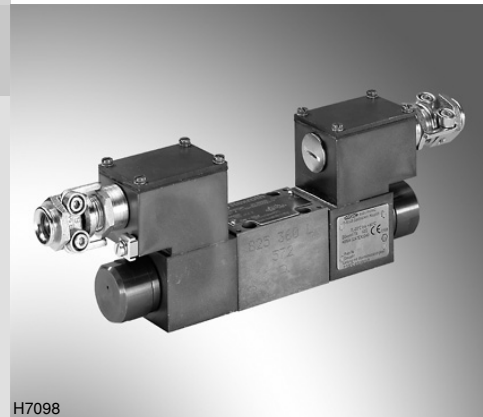

H7098

Actual product may differ

**ATEX units**  
**For explosive areas**

**Part II Data sheet**



**Information on the explosion protection:**

- Area of application in accordance with the Explosion Protection Directive 94/9/EC: **II 2G**
- Type of protection of the valve solenoid:  
Ex e mb IIC T4 Gb according to  
EN 60079-7:2007/EN 60079-18:2009

**Special features of seawater-resistant valves**

- The exterior of the valve housing is galvanically coated.
- The seawater-resistance is defined by "J" in the ordering code.

## What you need to know about these operating instructions

These operating instructions apply to the explosion-proof version of Rexroth valves and consist of the following three parts:

Part I General information 07010-X-B1

Part II Data sheet 29055-XE-B2

Part III Product-specific instructions 29055-XE-B3

**Operating instructions 29055-XE-B0**

You can find further information on the correct handling of Rexroth hydraulic products in our publication "General product information on hydraulic products" 07008.

## Table of contents

---

<b>Contents</b>	<b>Page</b>
Features	2
Ordering code and scope of delivery	3
Symbols	3
Function, section	4
Technical data	5
Information on the explosion protection	6
Electrical connection	7
Characteristic curves	8
Dimensions	10
Installation conditions	11

## Features

---

- Direct operated proportional valve for controlling flow direction and flow size for proper use in explosive atmospheres
- Seawater-resistant
- Spring-centered control spool
- For subplate mounting:
  - Porting pattern according to ISO 4401-03-02-05
- Subplates available in FE/ZN version (see page 10)
- Wet-pin DC solenoids
- Solenoid coil can be rotated by 90°
- Electrical connection as individual connection with cable gland

### Ordering code and scope of delivery

**4WRA 6 -2X/G24 XE J /**

Proportional directional valve  
for external control electronics

Size = 6

Symbols

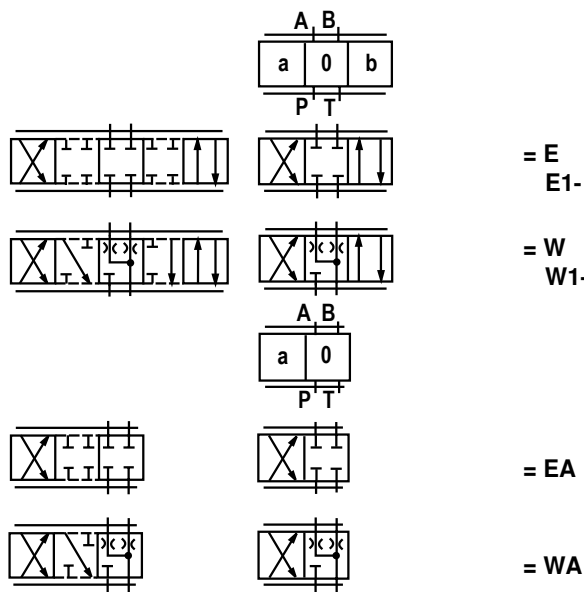

For control spools E1- and W1-, the following applies:

P → A:  $q_{V \max}$  and B → T:  $q_{V/2}$   
 P → B:  $q_{V/2}$  and A → T:  $q_{V \max}$

In the zero position, control spools W, W1 and WA have a connection from A → T and from B → T with approx. 3 % of the relevant nominal cross-section

**M =** NBR seals <sup>1)</sup>  
**V =** FKM seals  
**Important:**  
 Observe compatibility of seals  
 with hydraulic fluid used!

**J =** Surface protection  
 Seawater-resistant,  
 galvanized

**XE =** Explosion protection  
 "increased safety",  
 see details on the explosion protection  
 page 6

**G24 =** Supply voltage of the control electronics  
 24 V direct voltage

**2X =** Component series 20 to 29  
 (20 to 29: Unchanged installation and connection dimensions)

**Rated flow**  
**07 =** 6 l/min  
**15 =** 10 l/min  
**30 =** 18 l/min  
 Characteristic curves, see page 8

<sup>1)</sup> Suitable for mineral oils (HL, HLP) according to DIN 51524

#### Included in the scope of delivery:

Valve operating instructions with declaration of conformity in Part III

### Symbols

Type 4WRA 6 ...XE

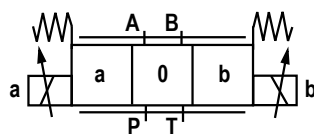

Type 4WRA 6 ...A...XE

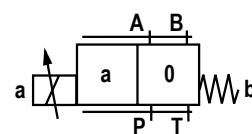

## Function, section

The 4/2 and 4/3 proportional directional valves are designed as direct operated valves in plate design. Operation is effected by means of proportional solenoids for explosive areas. The solenoids are actuated by external control electronics.

### Set-up:

The valve basically consists of:

- Housing (1) with connection surface
- Control spool (2) with compression springs (3 and 4)
- Solenoids (5 and 6) with central thread

### Functional description:

- With de-energized solenoids (5 and 6), central position of the control spool (2) by compression springs (3 and 4)
- Direct operation of the control spool (2) by energizing a proportional solenoid e.g. controlling solenoid "b" (6)
  - Control spool (2) is moved to the left in proportion to the electrical input signal
  - Connection from P → A and B → T via orifice-type cross-sections with progressive flow characteristics
- De-excitation of the solenoid (6)
  - The compression spring (3) brings the control spool (2) back into the central position

### Important:

Regarding the 4/3 version of the valves, only one solenoid may be actuated at a time.

### Type 4WRA 6 ...-2X/G24XEJ/V

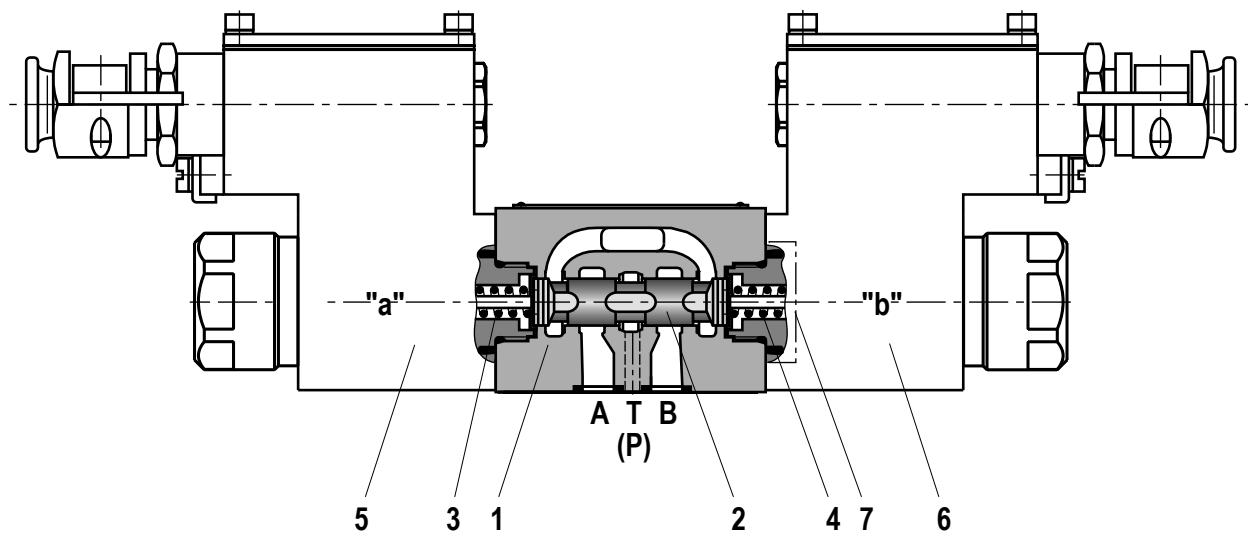

### Valve with 2 spool positions (type 4WRA 6 .A...XEJ...):

The function of this valve version basically corresponds to the valve with three spool positions. The 2 spool position valves are, however, only equipped with solenoid "a" (5). Instead of the 2nd proportional solenoid, there is a plug screw (7).

### Important:

The tank line must not be allowed to run empty. With corresponding installation conditions, a preload valve (preload pressure approx. 2 bar) must be installed.

## Technical data

### general

Installation position	Any; preferably horizontal		
Storage temperature range	°C	-20 ... +50	
Ambient temperature range	°C	-20 ... +60	
Weight	4WRA 6...XE	kg	4.4
	4WRA 6...A...XE	kg	2.7
Surface protection	Galvanized coating		

### hydraulic

Operating pressure range	Ports P, A, B	bar	Up to 315
	Port T	bar	Up to 210
Rated flows $q_{v, rated}$ with $\Delta_p = 10$ bar		l/min	6
		l/min	10
		l/min	18
Maximum flow		l/min	22
Hydraulic fluid	Mineral oil (HL, HLP) according to DIN 51524 additional hydraulic fluids upon request! Ignition temperature > 180 °C		
Hydraulic fluid temperature range		°C	-20 ... +80 (NBR seals)
			-15 ... +80 (FKM seals)
Viscosity range		mm <sup>2</sup> /s	15 ... 380 (preferably 30 ... 46)
Maximum admissible degree of contamination of the hydraulic fluid, cleanliness class according to ISO 4406 (c)	Class 17/15/12 <sup>1)</sup>		
Hysteresis		%	≤ 6
Range of inversion		%	≤ 2
Response sensitivity		%	≤ 1

### electric

Voltage type	Direct current or pulse-width modulated signal with pulse voltage ≤ 28 V and frequency ≥ 160 Hz up to max. 500 Hz		
Type of signal	Analog		
Maximum current per solenoid	A	1.03	
Duty cycle	%	100	
Coil temperature	°C	Up to 125	

<sup>1)</sup> The cleanliness classes specified for the components must be adhered to in hydraulic systems. Effective filtration prevents faults and at the same time increases the life cycle of the components. For the selection of the filters see [www.boschrexroth.com/filter](http://www.boschrexroth.com/filter).

## Information on the explosion protection

Area of application in accordance with the Explosion Protection Directive 94/9/EC	II 2G
Type of protection Valve according to EN 13463-1:2009 / EN 13463-5:2011	c T4 X
Type of protection Valve solenoid according to EN 60079-7:2007 / EN 60079-18:2009	Ex e mb IIC T4 Gb <sup>1)</sup>
Type examination certificate Solenoid	KEMA 02ATEX2240 X
"IECEX Certificate of Conformity" Solenoid	IECEX DEK 12.0068X
Special operating conditions for a safe application	<ul style="list-style-type: none"> <li>- In case of bank assembly, only one solenoid of all valves may be energized at a time.</li> <li>- In case of valves with two solenoids, maximally one of the solenoids may be energized at a time.</li> <li>- For the operation, only direct current or a pulse-width modulated signal with pulse voltage <math>\leq 28</math> V and frequency <math>\geq 160</math> Hz up to max. 500 Hz may be used.</li> </ul>

## Control electronics <sup>2)</sup>

Amplifier module for the control of explosion-proof proportional directional valves 4WRA...XE, 3DREP 6...XE and 4WRZ...XE	VT-MSPA2-200-1X/V0/0 according to data sheet 30228-200
Module for monitoring and limiting the solenoid currents with proportional valves	VT-MUXA2-2-1X/V0/1A according to data sheet 30290

<sup>1)</sup> Surface temperature  $> 50$  °C, provide contact protection

<sup>2)</sup> **Important:**

A monitoring circuit is to be provided for the monitoring of the solenoid current. We recommend operating the valves with the assemblies described herein.

## Electrical connection

The type-examination tested valve solenoid is equipped with a terminal box and a type-tested cable gland.

The connection is polarity-independent.

### Important:

Corresponding to the rated current, a fuse according to DIN 41571 and EN / IEC 60127 has to be connected ahead of every valve solenoid (max.  $3 \times I_{\text{rated}}$ ).

The shut-off threshold of the fuse has to match the prospective short-circuit current of the supply source.

The prospective short-circuit current of the supply source may amount to a maximum of 1500 A.

This fuse may only be installed outside the explosive area or must be of an explosion-proof design.

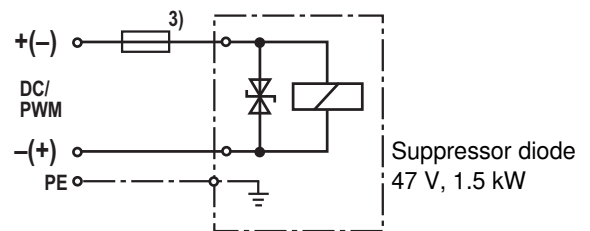
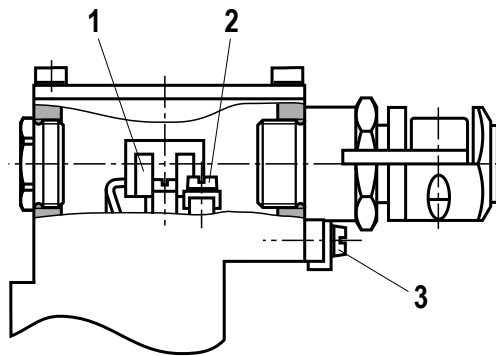

<sup>3)</sup> Recommended pre-fuse

Characteristics medium time-lag according to DIN 41571; 1.25 A

### Properties of the connection terminals

Position	Function	Connectable line cross-section
1	Operating voltage connection	Single-wire 0.75 ... 2.5 mm <sup>2</sup> Finely stranded 0.75 ... 1.5 mm <sup>2</sup>
2	Connection for protective earthing conductor	Single-wire max. 2.5 mm <sup>2</sup> Finely stranded max. 1.5 mm <sup>2</sup>
3	Connection for potential equalization conductor	Single-wire 4 ... 6 mm <sup>2</sup> Finely stranded 4 mm <sup>2</sup>

### Cable gland

Type approval	II 2G Ex e IIC Gb
Threaded connection	M20 x 1.5
Protection class according to EN 60529	IP66 <sup>1)</sup>
Line diameter	mm 9 ... 11
Sealing	Outer sheath sealing

### Connection line

Line type	<b>Non-armored</b> cables and lines (outer sheath sealing)
Temperature range	°C -30 ... > +110

<sup>1)</sup> If installed properly

## Characteristic curves (measured with HLP46, $\vartheta_{oil} = 40 \text{ }^\circ\text{C} \pm 5 \text{ }^\circ\text{C}$ )

Ordering code 07: 6 l/min with 10 bar valve pressure differential

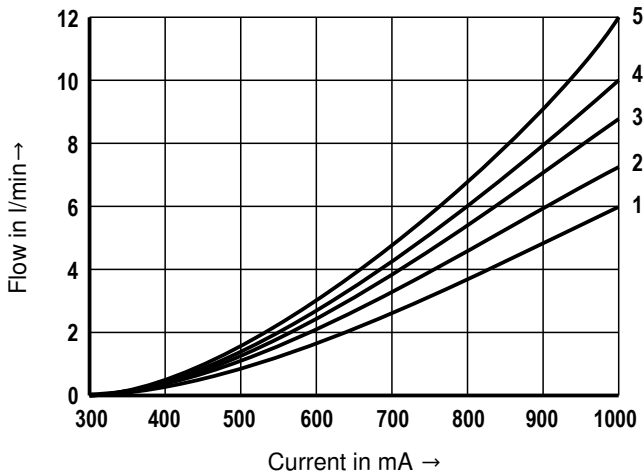

The following applies to all figures on this page:

- 1  $\Delta_p = 10$  bar constant
- 2  $\Delta_p = 20$  bar constant
- 3  $\Delta_p = 30$  bar constant
- 4  $\Delta_p = 50$  bar constant
- 5  $\Delta_p = 100$  bar constant

$\Delta_p$  = valve pressure differential according to DIN 24311 (inlet pressure minus load pressure and minus return flow pressure)

Ordering code 15: 10 l/min at a valve pressure differential of 10 bar

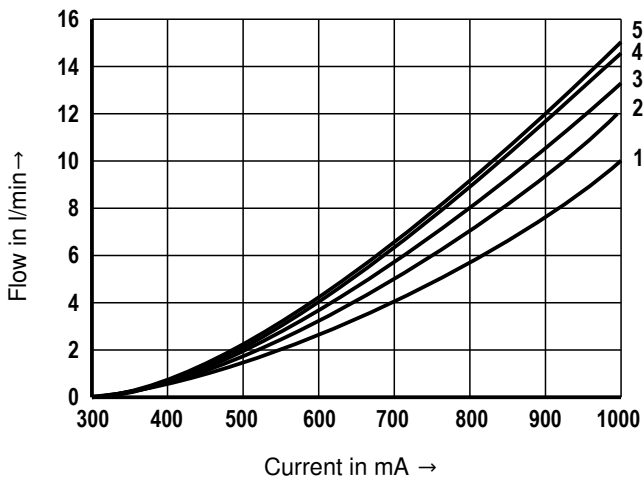

Ordering code 30: 18 l/min at a valve pressure differential of 10 bar

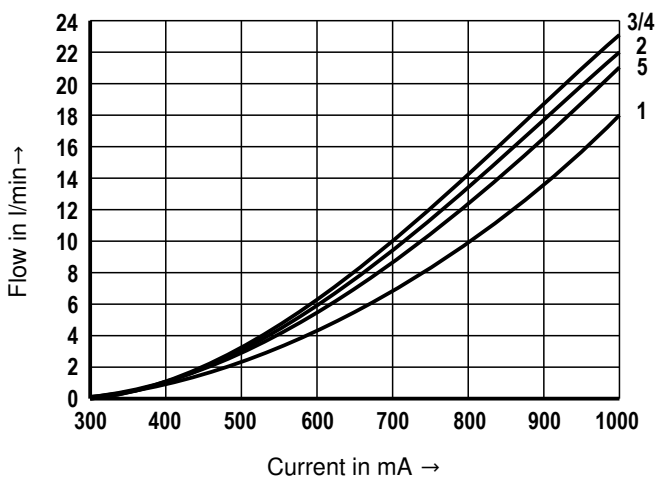



**Characteristic curves** (measured with HLP46,  $\vartheta_{oil} = 40 \text{ }^\circ\text{C} \pm 5 \text{ }^\circ\text{C}$ )

**Performance limit**

6 l/min rated flow

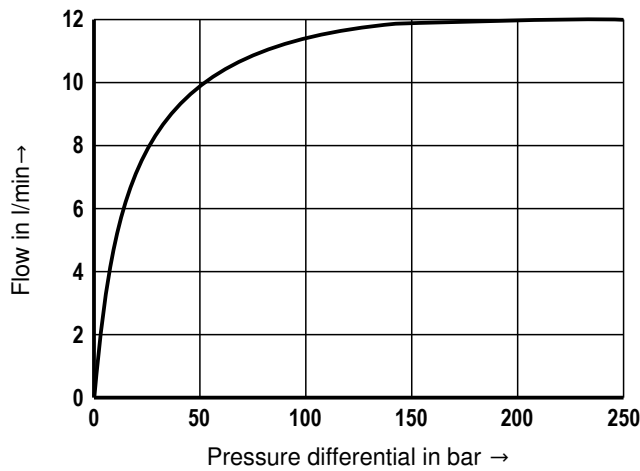

**Performance limit**

10 l/min rated flow

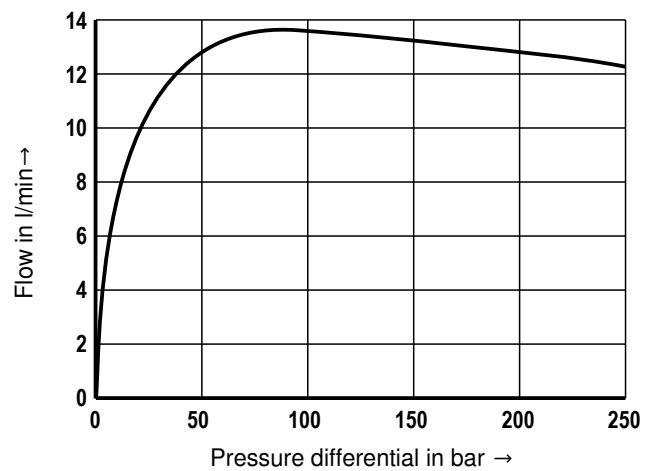

**Performance limit**

18 l/min rated flow

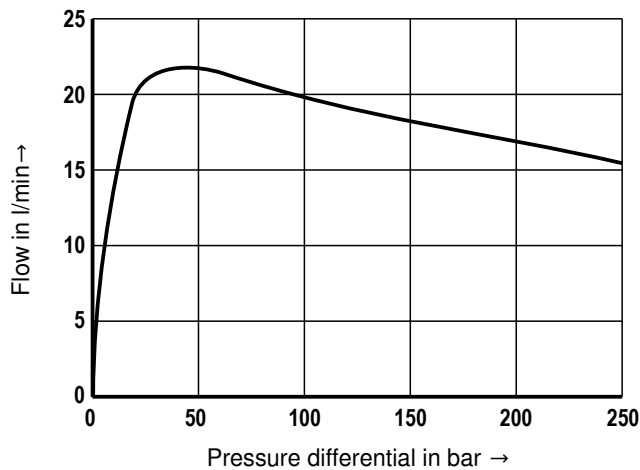

**Transition function with stepped electric input signals**

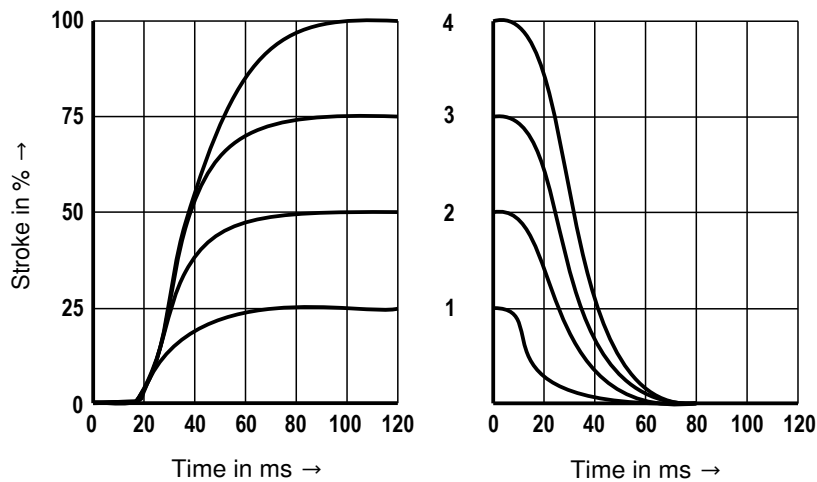

	Change of input signal [%]
1	0 → 25 → 0
2	0 → 50 → 0
3	0 → 75 → 0
4	0 → 100 → 0

Measured at pilot pressure  $p_{ST} = 10 \text{ bar}$

**Dimensions** (dimensions in mm)

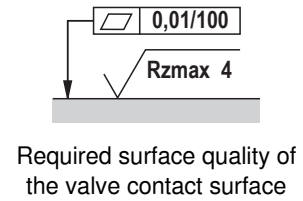
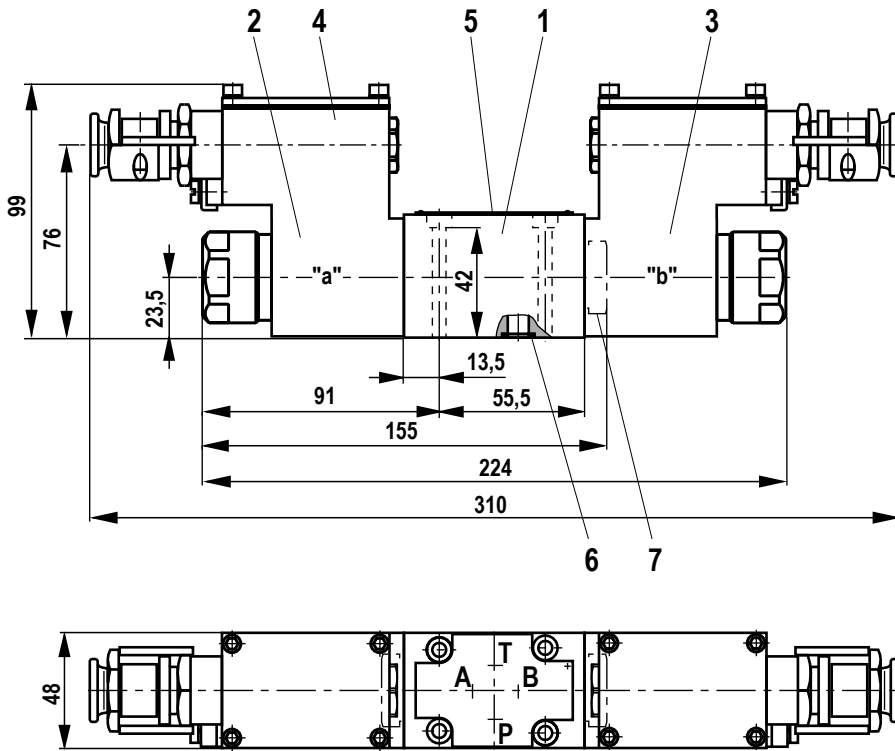

- 1 Valve housing
- 2 Proportional solenoid "a"
- 3 Proportional solenoid "b"
- 4 Terminal box
- 5 Name plate
- 6 Identical seal rings for ports P, A, B and T
- 7 Plug screw for valve with one solenoid (2 spool positions, version EA or WA)
- 8 Porting pattern according to ISO 4401-03-02-0-05  
Deviating from the standard:
  - Without locating pin
  - Ports P, A, B and T with  $\varnothing$  8 mm

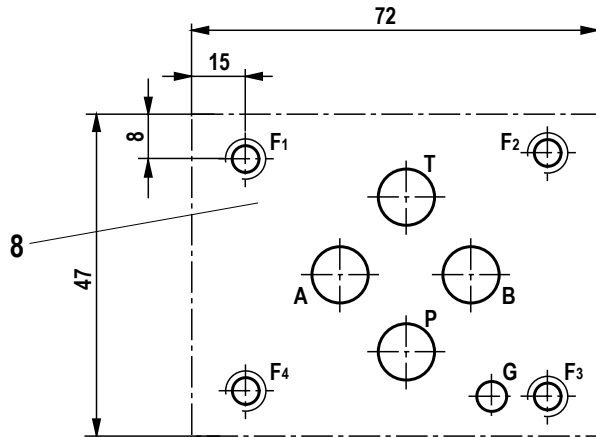

**Valve mounting screws**

For reasons of stability, exclusively use the following valve mounting screws:

**4 hexagon socket head cap screws**  
**ISO 4762-M5x50-10.9-fIZn-240h-L**  
 (friction coefficient 0.09 – 0.14 according to VDA 235-101)

Material no. **R913000064**  
 (must be ordered separately)

**Subplates**

- (without locating hole) G 341/01 FE/ZN (G1/4)
- G 342/01 FE/ZN (G3/8)
- G 502/01 FE/ZN (G1/2)

with dimensions as in the data sheet 45052  
 (must be ordered separately)

**Important:**

Subplates are no components in the sense of directive 94/9/EC and can be used after the manufacturer of the overall system has assessed the risk of ignition.

The G...FE/ZN versions are free from aluminum and/or magnesium and galvanized.

**Installation conditions** (dimensions in mm)

	Individual assembly	Bank assembly
Dimensions of the subplate	Minimum dimensions Length $\geq 64$ , width $\geq 58$ , height $\geq 25$	Minimum cross-section Height $\geq 60$ , width $\geq 85$
Thermal conductivity of the subplate	$\geq 38$ W/mK (EN-GJS-500-7)	
Minimum distance between the longitudinal valve axes	$\geq 55$ mm	

**Schematic diagram**

Individual assembly

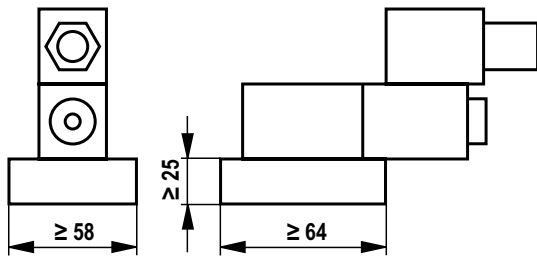

Bank assembly

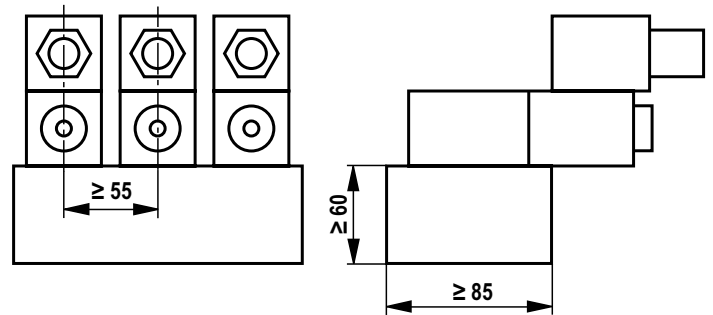
**Important:**

In case of bank assembly, only one solenoid of all valves may be energized at a time.

## Notes

---